

DOUZE CYCLES

Product Range 2017



PRO

URBAN

FAMILY

www.douze-cycles.com



Summary

Specs / Dimensions 3

Douze Cycles Innovations 5

Range PRO

P1 6

P2 7

P3e BionX 8

P5e GSD 9

Range URBAN

U1 10

U2 Pinion C1.12 11

U3e BionX 12

U5e Pinion C1.6 GSD 13

U6e GSD 14

Range FAMILY

F1 15

F3e BionX 16

F5e GSD 17

Frame Kit 18

Packs

Pack A, B et C 19

Canopy 20

Specs / Dimensions

REAR FRAME TYPES

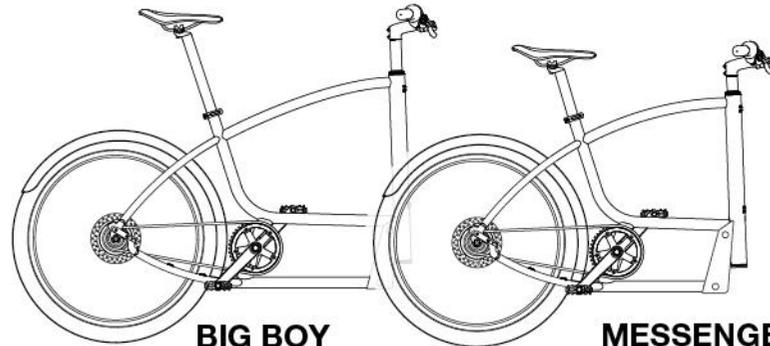

BIG BOY

For riders taller than 1.90m

MESSENGER

for riders measuring 1.50 to 1.90m

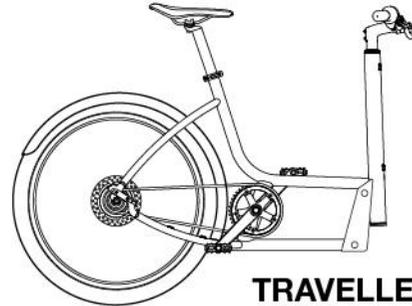

TRAVELLER

for riders measuring 1.50 to 1.90m

FRONT FRAME SIZES

400

Compact

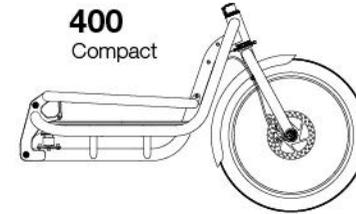

600

Standard

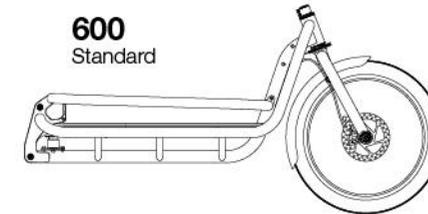

800

Extra-long

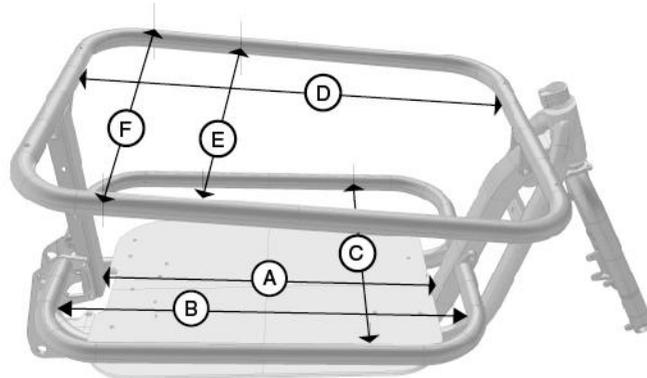
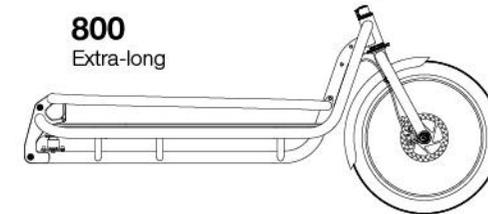

REAR FRAME DIMENSIONS

400

A : 400 mm
B : 460 mm
C : 460 mm
D : 515 mm
E : 522 mm
F : 586 mm

600

A : 600 mm
B : 660 mm
C : 460 mm
D : 715 mm
E : 522 mm
F : 586 mm

800

A : 800 mm
B : 860 mm
C : 560 mm
D : 915 mm
E : 622 mm
F : 686 mm

Specs / Dimensions

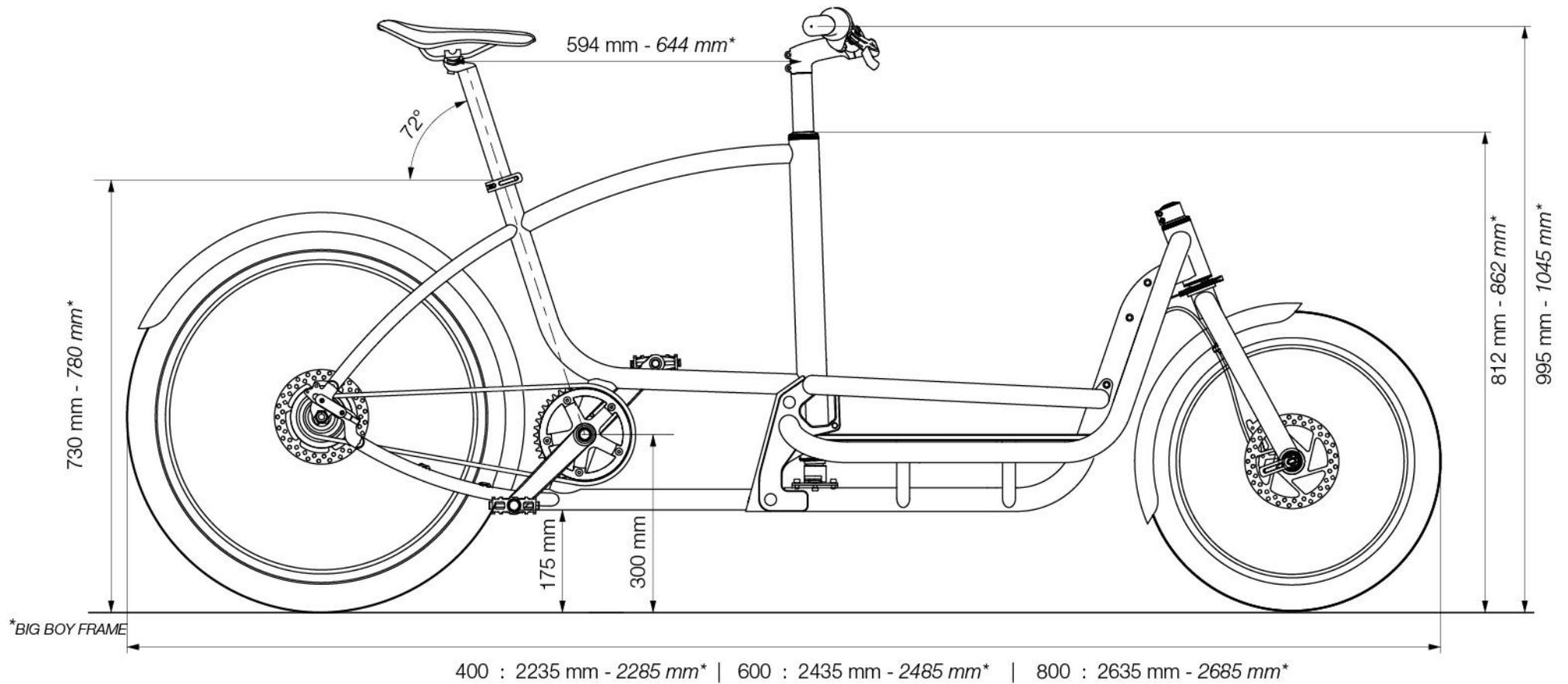

DOUZE Cycles Innovation

CABLE STEERING



CABLE STEERING FOR MORE COMFORT

DOUZE Cycles is the first manufacturer to sell cargo-bikes with cable steering. The advantages compared to standard cargo-bike steering systems (rod and ball ends) are undeniable:

Exceptional manoeuvrability! A front wheel capable of turning 75° to the right or to the left will allow you to easily manoeuvre your DOUZE and make U-turns in tight places

Our steering cable allows deep and sharp turns without the danger of the rider toppling over. The ad-hoc sheathed cable that we have designed is capable of working under extreme weather conditions.

QUICK RELEASE



SPLITABLE CARGO-BIKE

Our innovative quick-release system allows you to separate the front from the rear frame in less than 5 minutes.

You can transport your DOUZE in the trunk of your car or on a bike rack behind it. Separated into two parts, your DOUZE is easier to store when not used on a daily basis.

For different needs, you can change the frame! The 400 for instance could easily be replaced with the longer 800 frame in a couple of minutes.



P1 ULTRA RAW FOR PROFESSIONALS

P1 comes with a raw front and opens the door for customization to respond to specific needs of courier and delivery services. You can mix and match front and rear freely according to your needs.

We provide the essential DOUZE with the double (2X2) cable steering, the front/rear quick release system and the other cool features. It's up to you to personalize your DOUZE.

► For more information www.douze-cycles.com

FRAMES AND FORK

| | |
|--------------------|---|
| Rear frame | MESSENGER / TRAVELLER / BIG BOY Steel CrMo 4130 |
| Front frame | 400mm / 600mm / 800mm Aluminium 7005 T6 |
| Color | Matt black / Glossy white - Powder coated |
| Fork | Steel CrMo 4130 - QR 9mm Axle |
| Kickstand | Without kickstand |

WHEELS, BRAKES AND STEERING

| | |
|------------------------|---|
| Rear hubs | 135mm - 36H - 10mm Axle - Black |
| Front hubs | 100mm - 36H - QR 9mm Axle - Black |
| Rims | 20"+26"- 36H - Alu dble side - Eyelets |
| Tyres | SCHWALBE Kojak 26"+20"x1.35" |
| Brakes | TEKTRO Gemini Hydraulic - Disk 160mm |
| Mudguards | Without mudguards |
| Steering system | Steering by 2x2 cable + KELVAR |
| Steering column | housing |
| R/F Headset | Fix 1" 1/8 semi-integrated |

COMPONENTS

| | |
|-------------------------|----------------------------|
| Handlebar | Flat - 620mm |
| Stem | 90mm - D1: 28.6 - D2: 31.8 |
| Grips | Diamond |
| Saddle | Sport |
| Seatpost | 350mm (H.fl 88-102cm) |
| Seat clamp | Fix |
| Pedals | VP 469 |
| Front/Rear mount | 2 X Anti-theft axles |

TRANSMISSIONS

| | |
|-----------------------|---------------------------|
| Gears | SRAM Ext Der. XSeries 9V |
| Crankset | First DT1 - 39t |
| Gear ratios | S1: 2.43m - S9: 7.08m |
| Bottom bracket | Internal 68mm - 1.37"x24t |
| Chain | TAYA Octo DH 1/2"x5/64" |

OPTIONS

| | | | |
|---------------------|---|---------------------|--------------------------------|
| Gears | ALFINE8 / ALFINE11 / NUVINCI N380 / ROHLOFF | Seatpost | 400mm (H.fl 93-107cm) |
| Crankset | RT1 External BB 38t / 42t | Kickstand | Steel CrMo 4130 |
| Belt drive | GATES CARBON DRIVE | Mudguards | Stainless 60mm - Powder coated |
| Brakes | MAGURA MT4 Front + Rear - 180mm | Frame locker | ABUS ProShield 5850 NR |
| Light | B&M LUMOTEC + TOPLIGHT Small | Box | Alubox 600x400x600 |
| Dynamo wheel | SHUTTER PRECISION SP-PD8 | | Alubox 600x600x610 |
| F/R mount | 2 X Quick Release axles | | Alubox 800x600x610 |
| Handlebar | Moustache - 640mm | | KEP 600 200L |
| Saddle | Comfort / BROOKS B17 Black - Brown | | KEP 800 250L |



P2

JUST ADD YOUR GEAR!

For more comfort P2 offers you mudguards and a kickstand. Further customization is possible either with original DOUZE Cycles equipment or your own solution. You can mix and match front and rear freely according to your needs.

Original DOUZE Cycles accessories are available for the P2.

FRAMES AND FORK

| | |
|--------------------|---|
| Rear frame | MESSENGER / TRAVELLER / BIG BOY Steel CrMo 4130 |
| Front frame | 400mm / 600mm / 800mm Aluminium 7005 T6 |
| Color | Matt black / Glossy white - Powder coated |
| Fork | Steel CrMo 4130 - QR 9mm Axle |
| Kickstand | Steel CrMo 4130 |

WHEELS, BRAKES AND STEERING

| | |
|------------------------|---|
| Rear hubs | 135mm - 36H - 10mm Axle - Black |
| Front hubs | 100mm - 36H - QR 9mm Axle - Black |
| Rims | 20"+26" - 36H - Alu dble side - Eyelets |
| Tyres | SCHWALBE Marathon plus 26"+20"x1.75" |
| Brake | TEKTRO Gemini Hydraulic - Disk 160mm |
| Mudguards | Stainless 60mm - Powder coated |
| Steering system | Steering by 2x2 cable + KELVAR housing |
| Steering column | Fixe |
| R/F Headset | 1" 1/8 semi-integrated |

COMPONENTS

| | |
|-------------------------|----------------------------|
| Handlebar | Flat - 620mm |
| Stem | 90mm - D1: 28.6 - D2: 31.8 |
| Grips | Diamond |
| Saddle | Sport |
| Seatpost | 350mm (H.fl 88-102cm) |
| Seat clamp | Fix |
| Pedals | VP 469 |
| Front/Rear mount | 2 X Anti-theft axles |

TRANSMISSIONS

| | |
|-----------------------|---------------------------|
| Gears | SRAM Ext Der. XSeries 9V |
| Crankset | First DT1 - 39t |
| Gear ratios | S1: 2.43m - S8: 7.08m |
| Bottom bracket | Internal 68mm - 1.37"x24t |
| Chain | TAYA OCTO DH 1/2"x5/64" |

INCLUDED ACCESSORIES

| | |
|--------------|--------------------------------|
| Light | LED Light F/R USB rechargeable |
|--------------|--------------------------------|

OPTIONS

| | | | |
|---------------------|---|---------------------|---------------------------|
| Gears | ALFINE8 / ALFINE11 / NUVINCI N380 / ROHLOFF | Seatpost | 400mm (H.fl 93-107cm) |
| Crankset | RT1 External BB 38t / 42t | Wood board | Anti-skid plywood board |
| Belt drive | GATES CARBON DRIVE | Side tube | Aluminium - Powder coated |
| Brakes | MAGURA MT4 Front + Rear - 180mm | Frame locker | ABUS ProShield 5850 NR |
| Light | B&M LUMOTEC + TOPLIGHT Small | Box | Alubox 600x400x600 |
| Dynamo wheel | SHUTTER PRECISION SP-PD8 | | Alubox 600x600x610 |
| F/R mount | 2 X Quick Release axles | | Alubox 800x600x610 |
| Handlebar | Moustache - 640mm | | KEP 600 200L |
| Saddle | Comfort / BROOKS B17 Black - Brown | | KEP 800 250L |



P3

BionX

E-DRIVE FOR THE LAST MILE

P3 a P2 DOUZE Cycles enhanced with a BionX motor which supports your ride substantially. The regenerative braking controls your descents and recharges the battery as you ride. The high output batteries stand for a long range.

A large choice of original DOUZE Cycles accessories is available for the P3.

FRAMES AND FORK

| | |
|--------------------|---|
| Rear frame | MESSENGER / TRAVELLER / BIG BOY Steel CrMo 4130 |
| Front frame | 400mm / 600mm / 800mm Aluminium 7005 T6 |
| Color | Matt black / Glossy white - Powder coated |
| Fork | Steel CrMo 4130 - QR 9mm Axle |
| Kickstand | Steel CrMo 4130 |

WHEELS, BRAKES AND STEERING

| | |
|------------------------|---|
| Rear hubs | 135mm - 36H - 10mm Axle - Black |
| Front hubs | 100mm - 36H - QR 9mm Axle - Black |
| Rims | 20"+26" - 36H - Alu dble side - Eyelets |
| Tyres | SCHWALBE Marathon plus 26"+20"x1.75" |
| Brakes | TEKTRO Gemini Hydraulic - Disk 160mm |
| Mudguards | Stainless 60mm - Powder coated |
| Steering system | Steering by 2x2 cable + KEVLAR housing |
| Steering column | Fixe |
| R/F Headset | 1" 1/8 semi-integrated |

COMPONENTS

| | |
|-------------------------|----------------------------|
| Handlebar | Flat - 620mm |
| Stem | 90mm - D1: 28.6 - D2: 31.8 |
| Grips | Diamond |
| Saddle | Sport |
| Seatpost | 350mm (H.fl 88-102cm) |
| Seat clamp | Fix |
| Pedals | VP 469 |
| Front/Rear mount | 2 X Anti-theft axles |

TRANSMISSIONS

| | |
|-----------------------|-------------------------------|
| Gears | SRAM Ext Der. XSeries 9V |
| Crankset | First DT1 - 39t |
| Gear ratios | S1: 2.43m - S8: 7.08m |
| Bottom bracket | Internal 68mm - 1.37"x24t |
| Chain | TAYA Octo DH 1/2"x5/64" |
| Motor | BionX D250 DV / 250 W |
| Battery | Li-Ion 48V / 11.6 Ah / 555 Wh |

INCLUDED ACCESSORIES

| | |
|--------------|--------------------------------|
| Light | LED Light F/R USB rechargeable |
|--------------|--------------------------------|

OPTIONS

| | | | |
|---------------------|------------------------------------|---------------------|---------------------------|
| Crankset | T1 External BB 38t / 42t | Side tube | Aluminium - Powder coated |
| Belt drive | GATES CARBON DRIVE | Frame locker | ABUS ProShield 5850 NR |
| Brakes | MAGURA MT4 Front + Rear - 180mm | Box | Alubox 600x400x600 |
| Light | B&M LUMOTEC + TOPLIGHT Small | | Alubox 600x600x610 |
| Dynamo wheel | SHUTTER PRECISION SP-PD8 | | Alubox 800x600x610 |
| F/R mount | 2 X Quick Release axles | | KEP 600 200L |
| Handlebar | Moustache - 640mm | | KEP 800 250L |
| Saddle | Comfort / BROOKS B17 Black - Brown | | |
| Seatpost | 400mm (H.fl 93-107cm) | | |
| Wood board | Anti-skid plywood board | | |



P5e
GSD

MORE VIGOUR

The GO SwissDrive motor is tested to industry standard IP64, designed to prevent the ingress of dust or spray. This robust quality protects customers who use their bike in harsh conditions, such as when carrying out delivery services with heavy loads.

Energy recovery (recuperation) means less wear on the brakes when riding downhill. Known also in Formula 1 as KERS (Kinetic Energy Recovery System), it is only possible on rear wheel hub motors.

► For more information www.douze-cycles.com

FRAMES AND FORK

| | |
|--------------------|---|
| Rear frame | MESSENGER / TRAVELLER / BIG BOY Steel CrMo 4130 |
| Front frame | 400mm / 600mm / 800mm Aluminium 7005 T6 |
| Color | Matt black / Glossy white - Powder coated |
| Fork | Steel CrMo 4130 - QR 9mm Axle |
| Kickstand | Steel CrMo 4130 |

WHEELS, BRAKES AND STEERING

| | |
|------------------------|--|
| Rear hubs | 135mm - 36H - 10mm Axle - Black |
| Front hubs | 100mm - 36H - QR 9mm Axle - Black |
| Rims | 20"+26" - 36H - Alu dble side - Eyelets |
| Tyres | SCHWALBE Marathon plus 26"+20"x1.75" |
| Brakes | TEKTRO Gemini Hydraulic - Disk 180 mm |
| Mudguards | Stainless 60mm - Powder coated |
| Steering system | Steering by 2x2 cable + KEVLAR housing |
| Steering column | Fixe |
| R/F Headset | 1" 1/8 semi-integrated |

COMPONENTS

| | |
|-------------------------|----------------------------|
| Handlebar | Flat - 620mm |
| Stem | 90mm - D1: 28.6 - D2: 31.8 |
| Grips | Diamond |
| Saddle | Sport |
| Seatpost | 350mm (H.fl 88-102cm) |
| Seat clamp | Fix |
| Pedals | VP 469 |
| Front/Rear mount | 2 X Anti-theft axles |

TRANSMISSIONS

| | |
|-----------------------|----------------------------------|
| Gears | SRAM Ext Der. XSeries 9V |
| Crankset | First RT1 - 42t |
| Gear ratios | S1 : 2.53 m S9 : 7.83 m |
| Bottom bracket | External |
| Chain | TAYA Octo DH 1/2"x5/64" |
| Motor | GO SwissDrive / 250 W |
| Battery | BMZ Li-Ion 36V /15,5 Ah / 558 Wh |

INCLUDED ACCESSORIES

| | |
|--------------|--------------------------------|
| Light | LED Light F/R USB rechargeable |
|--------------|--------------------------------|

OPTIONS

| | | | |
|---------------------|------------------------------------|---------------------|---------------------------|
| Crankset | T1 External BB 38t / 42t | Side tube | Aluminium - Powder coated |
| Belt drive | GATES CARBON DRIVE | Frame locker | ABUS ProShield 5850 NR |
| Brakes | MAGURA MT4 Front + Rear - 180mm | Box | Alubox 600x400x600 |
| Light | B&M LUMOTEC + TOPLIGHT Small | | Alubox 600x600x610 |
| Dynamo wheel | SHUTTER PRECISION SP-PD8 | | Alubox 800x600x610 |
| F/R mount | 2 X Quick Release axles | | KEP 600 200L |
| Handlebar | Moustache - 640mm | | KEP 800 250L |
| Saddle | Comfort / BROOKS B17 Black - Brown | | |
| Seatpost | 400mm (H.fl 93-107cm) | | |
| Wood board | Anti-skid plywood board | | |



U1 THE BASIC URBAN VERSION

The urban range offers many combinations: three types of rear frame, three front frame lengths, two standard colours... and it comes with the unique DOUZE features: the double (2X2) cable steering and the quick unlocking system.

U1 is the basic version of the urban range of DOUZE Cycles. The front frame is equipped with an anti-skid plywood board and side tubes and rechargeable LED lights in the front and rear.

It can be ordered with optional equipment or enhanced at a later stage. It can also be converted at any time into an e-cargo-bike by installing a hub motor.

► For more information www.douze-cycles.com

Range URBAN

FRAMES AND FORK

| | |
|--------------------|---|
| Rear frame | MESSENGER / TRAVELLER / BIG BOY Steel CrMo 4130 |
| Front frame | 400mm / 600mm / 800mm Aluminium 7005 T6 |
| Color | Matt black / Glossy white - Powder coated |
| Fork | Steel CrMo 4130 - QR 9mm Axle |
| Kickstand | Steel CrMo 4130 |

WHEELS, BRAKES AND STEERING

| | |
|------------------------|---|
| Rear hubs | 135mm - 36H - 10mm Axle - Black |
| Front hubs | 100mm - 36H - QR 9mm Axle - Black |
| Rims | 20"+26" - 36H - Alu dble side - Eyelets |
| Tyres | SCHWALBE Marathon plus 26"+20"x1.75" |
| Brakes | TEKTRO Gemini Hydraulic Disk 160mm |
| Mudguards | Stainless 60mm - Powder coated |
| Steering system | Steering by 2x2 cable + KEVLAR housing |
| Steering column | Adjustable - Easy up |
| R/F Headset | 1" 1/8 semi-integrated |

COMPONENTS

| | |
|-------------------------|---|
| Handlebar | Flat - 620mm |
| Stem | 90mm - D1: 28.6 - D2: 31.8 |
| Grips | Diamond |
| Saddle | Sport |
| Seatpost | D 31.6 - Adjustable 2 parts (H82-110cm) |
| Seat clamp | Fix |
| Pedals | VP 469 |
| Front/Rear mount | 2 X Anti-theft axles |

TRANSMISSIONS

| | |
|-----------------------|---------------------------|
| Gears | SHIMANO ALFINE 8 - 19t |
| Crankset | First DT1 - 39t |
| Gear ratios | S1: 2.16m - S8: 6.62m |
| Bottom bracket | Internal 68mm - 1.37"x24t |
| Chain | TAYA Octo DH 1/2"x3/32" |

INCLUDED ACCESSORIES

| | |
|-------------------|--------------------------------|
| Light | LED Light F/R USB rechargeable |
| Wood board | Anti-skid plywood board |
| Side tube | Aluminium - Powder coated |

OPTIONS

| | | | |
|---------------------|------------------------------------|---------------------|----------------|
| Gears | ALFINE11 / NUVINCI N380 / ROHLOFF | Pack | A / B / C |
| Crankset | RT1 External BB 38t / 42t | Canopy | 600 / 800 |
| Belt drive | GATES CARBON DRIVE | Support cosy | STECO Baby-mee |
| Brakes | MAGURA MT4 Front + Rear - 180mm | | |
| Light | B&M LUMOTEC + TOPLIGHT Small | | |
| Dynamo wheel | SHUTTER PRECISION SP-PD8 | | |
| F/R mount | 2 X Quick Release axles | | |
| Handlebar | Moustache - 640mm | | |
| Saddle | Comfort / BROOKS B17 Black - Brown | | |
| Frame locker | ABUS ProShield 5850 NR | | |



HIGHTECH MEETS DOUZE Cycles!

Enthusiasts of PINION expect the same comfort on their cargo bike. U2 comes with a PINION C1.12 offering 12 real gears with 600% overall ratio.

U2 PINION C1.12 can also be upgraded with a GATES carbon drive belt drive. It can be ordered with optional equipment or enhanced at a later stage. At any time, it can be converted into an e-cargo-bike by installing a hub motor.

Our large choice of original DOUZE Cycles accessories is available for the U2.

► For more information www.douze-cycles.com

Range URBAN

FRAMES AND FORK

| | |
|--------------------|--|
| Rear frame | MESSENGER / TRAVELLER Steel CrMo 4130 |
| Front frame | 400mm / 600mm / 800mm Aluminium 7005 T6 |
| Color | Matt black / Glossy white - Powder coated |
| Fork | Steel CrMo 4130 - QR 9mm Axle |
| Kickstand | Steel CrMo 4130 |

WHEELS, BRAKES AND STEERING

| | |
|------------------------|---|
| Rear hubs | 135mm - 36H - 10mm Axle - Black |
| Front hubs | 100mm - 36H - QR 9mm Axle - Black |
| Rims | 20"+26" - 36H - Alu dble side - Eyelets |
| Tyres | SCHWALBE Marathon plus 26"+20"x1.75" |
| Brakes | MAGURA MT4 Front + Rear - 180mm |
| Mudguards | Stainless 60mm - Powder coated |
| Steering system | Steering by 2x2 cable + KEVLAR housing |
| Steering column | Adjustable - Easy up |
| R/F Headset | 1" 1/8 semi-integrated |

COMPONENTS

| | |
|-------------------------|---|
| Handlebar | Flat - 620mm |
| Stem | 90mm - D1: 28.6 - D2: 31.8 |
| Grips | Diamond |
| Saddle | Sport |
| Seatpost | D 31.6 - Adjustable 2 parts (H82-110cm) |
| Seat clamp | Fix |
| Pedals | VP 469 |
| Front/Rear mount | 2 X Anti-theft axles |

TRANSMISSIONS

| | |
|--------------------|-------------------------|
| Gears | PINION C1.12 - 600% |
| Sproket | F: 30t R: 26t |
| Gear ratios | S1: 1.40m - S12: 8.45m |
| Chain | TAYA Octo DH 1/2"x3/32" |

INCLUDED ACCESSORIES

| | |
|-------------------|--------------------------------|
| Light | LED Light F/R USB rechargeable |
| Wood board | Anti-skid plywood board |
| Side tube | Aluminium - Powder coated |

OPTIONS

| | |
|---------------------|------------------------------------|
| Belt drive | GATES CARBON DRIVE |
| Light | B&M LUMOTEC + TOPLIGHT Small |
| Dynamo wheel | SHUTTER PRECISION SP-PD8 |
| F/R mount | 2 X Quick Release axles |
| Handlebar | Moustache - 640 mm |
| Saddle | Comfort / BROOKS B17 Black - Brown |
| Frame locker | ABUS ProShield 5850 NR |
| Pack | A / B / C |
| Canopy | 600 / 800 |
| Support cosy | STECO Baby-mee |



U3e
BionX

URBAN E-DRIVE

An urban DOUZE enhanced with a BionX motor which supports your ride substantially. The regenerative braking controls your descents and recharges the battery as you ride. The high output batteries stand for a long range.

You can choose from a large range of different options to customize your DOUZE according to your needs.

All original DOUZE Cycles accessories are available for the U3e.

► For more information www.douze-cycles.com

Range URBAN

FRAMES AND FORK

| | |
|--------------------|---|
| Rear frame | MESSENGER / TRAVELLER / BIG BOY Steel CrMo 4130 |
| Front frame | 400mm / 600mm / 800mm Aluminium 7005 T6 |
| Color | Matt black / Glossy white - Powder coated |
| Fork | Steel CrMo 4130 - QR 9mm Axle |
| Kickstand | Steel CrMo 4130 |

WHEELS, BRAKES AND STEERING

| | |
|------------------------|---|
| Rear hubs | 135mm - 36H - 10mm Axle - Black |
| Front hubs | 100mm - 36H - QR 9mm Axle - Black |
| Rims | 20"+26"- 36H - Alu dble side - Eyelets |
| Tyres | SCHWALBE Marathon plus 26"+20"x1.75" |
| Brakes | MAGURA MT4 AV-AR - 180mm |
| Mudguards | Stainless 60mm - Powder coated |
| Steering system | Steering by 2x2 cable + KELVLAR housing |
| Steering column | Adjustable - Easy up |
| R/F Headset | 1" 1/8 semi-integrated |

COMPONENTS

| | |
|-------------------------|---|
| Handlebar | Flat - 620mm |
| Stem | 90mm - D1: 28.6 - D2: 31.8 |
| Grips | Diamond |
| Saddle | Sport |
| Seatpost | D 31.6 - Adjustable 2 parts (H82-110cm) |
| Seat clamp | Fix |
| Pedals | VP 469 |
| Front/Rear mount | 2 X Anti-theft axles |

TRANSMISSIONS

| | |
|-----------------------|-------------------------------|
| Gears | SRAM Ext Der. XSeries 9V |
| Crankset | First DT1 - 39t |
| Gear ratios | S1: 2.43m - S9: 7.08m |
| Bottom bracket | Internal 68mm - 1.37"x24t |
| Chain | TAYA Octo DH 1/2" X 5/64" |
| Motor | BionX D250 DV / 250 W |
| Battery | Li-Ion 48V / 11.6 Ah / 555 Wh |

INCLUDED ACCESSORIES

| | |
|-------------------|--------------------------------|
| Light | LED Light F/R USB rechargeable |
| Wood board | Anti-skid plywood board |
| Side tube | Aluminium - Powder coated |

OPTIONS

| | |
|---------------------|------------------------------------|
| Crankset | RT1 External BB 38t / 42t |
| Light | B&M LUMOTEC + TOPLIGHT Small |
| F/R mount | 2 X Quick Release axles |
| Handlebar | Moustache - 640 mm |
| Saddle | Comfort / BROOKS B17 Black - Brown |
| Frame locker | ABUS ProShield 5850 NR |
| Pack | A / B / C |
| Canopy | 600 / 800 |
| Support cosy | STECO Baby-mee |



U5e

PINION C1.6
GSD

PREMIUM EDITION

The U5e is your powerful and classy companion at all times. The Go SwissDrive motor provides powerful support going uphill as well as energy recovery on downhill rides.

In combination with a PINION C1.6 offering 6 real gears with 295 % overall ratio the U5e is a sophisticated cargo-bike.

All original DOUZE Cycles accessories are available for the U5e.

► For more information www.douze-cycles.com

Range URBAN

FRAMES AND FORK

| | |
|--------------------|--|
| Rear frame | MESSENGER / TRAVELLER Steel CrMo 4130 |
| Front frame | 400mm / 600mm / 800mm Aluminium 7005 T6 |
| Color | Matt black / Glossy white - Powder coated |
| Fork | Steel CrMo 4130 - QR 9mm Axle |
| Kickstand | Steel CrMo 4130 |

WHEELS, BRAKES AND STEERING

| | |
|------------------------|---|
| Rear hubs | 135mm - 36H - 10mm Axle - Black |
| Front hubs | 100mm - 36H - QR 9mm Axle - Black |
| Rims | 20"+26" - 36H - Alu dble side - Eyelets |
| Tyres | SCHWALBE Marathon plus 26"+20"x1.75" |
| Brakes | MAGURA MT4 Front + Rear - 180mm |
| Mudguards | Stainless 60mm - Powder coated |
| Steering system | Steering by 2x2 cable + KEVLAR housing |
| Steering column | Adjustable - Easy up |
| R/F Headset | 1" 1/8 semi-integrated |

COMPONENTS

| | |
|-------------------------|---|
| Handlebar | Flat - 620mm |
| Stem | 90mm - D1: 28.6 - D2: 31.8 |
| Grips | Diamond |
| Saddle | Sport |
| Seatpost | D 31.6 - Adjustable 2 parts (H82-110cm) |
| Seat clamp | Fix |
| Pedals | VP 469 |
| Front/Rear mount | 2 X Anti-theft axles |

TRANSMISSIONS

| | |
|--------------------|-----------------------------------|
| Gears | PINION C1.6 - 295% |
| Sprocket | F: 30t R: 26t |
| Gear ratios | S1: 1.44m - S9: 8.18m |
| Chain | TAYA Octo DH 1/2" X 3/32" |
| Motor | GO Swissdrive / 250 W |
| Battery | BMZ Li-Ion 36V / 15,5 Ah / 558 Wh |

INCLUDED ACCESSORIES

| | |
|-------------------|--------------------------------|
| Light | LED Light F/R USB rechargeable |
| Wood board | Anti-skid plywood board |
| Side tube | Aluminium - Powder coated |

OPTIONS

| | |
|---------------------|------------------------------------|
| Crankset | RT1 External BB 38t / 42t |
| Belt drive | GATES CARBON DRIVE |
| Light | B&M LUMOTEC + TOPLIGHT Small |
| F/R mount | 2 X Quick Release axles |
| Handlebar | Moustache - 640 mm |
| Saddle | Comfort / BROOKS B17 Black - Brown |
| Frame locker | ABUS ProShield 5850 NR |
| Pack | A / B / C |
| Canopy | 600 / 800 |
| Support cosy | STECO Baby-Mee |



U6e
GSD

MODERN AND DYNAMIC

Running powerfully and smoothly – the GO SwissDrive System motor provides sufficient propulsion at any time. Power where it has greatest effect: directly on the rear wheel hub. Without any detours. And without unnecessary wear on chain. Energy recovery (recuperation) means less wear on the brakes when riding downhill.

U6e GSD offers urban commuters smartphone connectivity via Bluetooth integrated into the new EVO display.

► For more information www.douze-cycles.com

Range URBAN

FRAMES AND FORK

| | |
|--------------------|---|
| Rear frame | MESSENGER / TRAVELLER / BIG BOY Steel CrMo 4130 |
| Front frame | 400mm / 600mm / 800mm Aluminium 7005 T6 |
| Color | Matt black / Glossy white - Powder coated |
| Fork | Steel CrMo 4130 - QR 9mm Axle |
| Kickstand | Steel CrMo 4130 |

WHEELS, BRAKES AND STEERING

| | |
|------------------------|---|
| Rear hubs | 135mm - 36H - 10mm Axle - Black |
| Front hubs | 100mm - 36H - QR 9mm Axle - Black |
| Rims | 20"+26" - 36H - Alu dble side - Eyelets |
| Tyres | SCHWALBE Marathon plus 26"+20"x1.75" |
| Brakes | MAGURA MT4 AV-AR - 180mm |
| Mudguards | Stainless 60mm - Powder coated |
| Steering system | Steering by 2x2 cable + KELVLAR housing |
| Steering column | Adjustable - Easy up |
| R/F Headset | 1" 1/8 semi-integrated |

COMPONENTS

| | |
|-------------------------|---|
| Handlebar | Flat - 620mm |
| Stem | 90mm - D1: 28.6 - D2: 31.8 |
| Grips | Diamond |
| Saddle | Sport |
| Seatpost | D 31.6 - Adjustable 2 parts (H82-110cm) |
| Seat clamp | Fix |
| Pedals | VP 469 |
| Front/Rear mount | 2 X Anti-theft axles |

TRANSMISSIONS

| | |
|-----------------------|----------------------------------|
| Gears | SRAM Ext Der. XSeries 9V |
| Crankset | First RT1 - 42t |
| Gear ratios | S1 : 2.53m S9 : 7.83m |
| Bottom bracket | External |
| Chain | TAYA Octo DH 1/2" X 5/64" |
| Motor | GO SwissDrive / 250 W |
| Battery | BMZ Li-Ion 36V /15,5 Ah / 558 Wh |

INCLUDED ACCESSORIES

| | |
|-------------------|--------------------------------|
| Light | LED Light F/R USB rechargeable |
| Wood board | Anti-skid plywood board |
| Side tube | Aluminium - Powder coated |

OPTIONS

| | |
|---------------------|------------------------------------|
| Crankset | RT1 External BB 38t / 42t |
| Light | B&M LUMOTEC + TOPLIGHT Small |
| F/R mount | 2 X Quick Release axles |
| Handlebar | Moustache - 640 mm |
| Saddle | Comfort / BROOKS B17 Black - Brown |
| Frame locker | ABUS ProShield 5850 NR |
| Pack | A / B / C |
| Canopy | 600 / 800 |
| Support cosy | STECO Baby-mee |



F1 FAMILY FIRST!

Designed by and for parents who want to carry their kids safely and comfortably, the F1 combines a TRAVELLER rear frame with a 600 or 800 front frame. It comes with a B pack which includes a seat for kids with two 3-point harnesses, the "box", a flexible waterproof cover and a plastic underside (installed beneath the floor).

The double (2X2) cable steering lets you turn the front wheel 75° and the unlocking system allows you to quickly separate the front and rear frames.

Looking for a rain cover? As an option you can add our canopy available in two sizes.

► For more information www.douze-cycles.com

Range FAMILY

FRAMES AND FORK

| | |
|--------------------|---|
| Rear frame | MESSENGER / TRAVELLER / BIG BOY Steel CrMo 4130 |
| Front frame | 600mm / 800mm Aluminium 7005 T6 |
| Color | Matt black / Glossy white - Powder coated |
| Fork | Steel CrMo 4130 - QR 9mm Axle |
| Kickstand | Steel CrMo 4130 |

WHEELS, BRAKES AND STEERING

| | |
|------------------------|---|
| Rear hubs | 135mm - 36H - 10mm Axle - Black |
| Front hubs | 100mm - 36H - QR 9mm Axle - Black |
| Rims | 20"+26" - 36H - Alu dble side - Eyelets |
| Tyres | SCHWALBE Big Apple 26"+20"x2.0" |
| Brakes | TEKTRO Gemini Hydraulic - Disk 160mm |
| Mudguards | Stainless 60mm - Powder coated |
| Steering system | Steering by 2x2 cable + KEVLAR housing |
| Steering column | Adjustable - Easy up |
| R/F Headset | 1" 1/8 semi-integrated |

OPTIONS

| | | | |
|---------------------|------------------------------------|---------------------|----------------|
| Gears | ALFINE11 / NUVINCI N380 / ROHLOFF | Canopy | 600 / 800 |
| Crankset | RT1 External BB 38t / 42t | Support cosy | STECO Baby-Mee |
| Belt drive | GATES CARBON DRIVE | | |
| Brakes | MAGURA MT4 Front + Rear - 180mm | | |
| Light | B&M LUMOTEC + TOPLIGHT Small | | |
| Dynamo wheel | SHUTTER PRECISION SP-PD8 | | |
| F/R mount | 2 X Quick Release axles | | |
| Handlebar | Flat - 620mm | | |
| Saddle | Comfort / BROOKS B17 Black - Brown | | |
| Frame locker | ABUS ProShield 5850 NR | | |

COMPONENTS

| | |
|-------------------------|---|
| Handlebar | Moustache - 640mm |
| Stem | 10mm - D1: 28.6 - D2: 31.8 |
| Grips | Ergonomic |
| Saddle | Comfort |
| Seatpost | D 31.6 - Adjustable 2 parts (H82-110cm) |
| Seat clamp | Fix |
| Pedals | City - VP 856 - anti-skid |
| Front/Rear mount | 2 X Anti-theft axles |

TRANSMISSIONS

| | |
|-----------------------|---------------------------|
| Gears | SHIMANO ALFINE 8 - 19t |
| Crankset | First DT1 - 39t |
| Gear ratios | S1: 2.16m - S8: 6.62m |
| Bottom bracket | Internal 68mm - 1.37"x24t |
| Chain | TAYA Octo DH 1/2"x3/32" |

INCLUDED ACCESSORIES

| | |
|-------------------|--------------------------------|
| Light | LED Light F/R USB rechargeable |
| Wood board | Anti-skid plywood board |
| Side tube | Aluminium - Powder coated |
| Pack | B |



F3e
BionX

E-DRIVE FOR FAMILIES

A Family DOUZE enhanced with a BionX motor that supports your ride substantially. The regenerative braking controls your descents and recharges the battery as you ride. The high output batteries stand for a long range.

The double (2X2) cable steering lets you turn the front wheel 75° and the unlocking system allows you to quickly separate the front and rear frame.

Looking for a rain cover? As an option you can add our canopy available in two sizes.

► For more information www.douze-cycles.com

Range FAMILY

FRAMES AND FORK

| | |
|--------------------|---|
| Rear frame | MESSENGER / TRAVELLER / BIG BOY Steel CrMo 4130 |
| Front frame | 600mm / 800mm Aluminium 7005 T6 |
| Color | Matt black / Glossy white - Powder coated |
| Fork | Steel CrMo 4130 - QR 9mm Axle |
| Kickstand | Steel CrMo 4130 |

WHEELS, BRAKES AND STEERING

| | |
|------------------------|---|
| Rear hubs | 135mm - 36H - 10mm Axle - Black |
| Front hubs | 100mm - 36H - QR 9mm Axle - Black |
| Rims | 20"+26"- 36H - Alu dble side - Eyelets |
| Tyres | SCHWALBE Big Apple 26"+20"x2.0" |
| Brakes | TEKTRO Gemini Hydraulic - Disk 160mm |
| Mudguards | Stainless 60mm - Powder coated |
| Steering system | Steering by 2x2 cable + KEVLAR housing |
| Steering column | Adjustable - Easy up |
| R/F Headset | 1" 1/8 semi-integrated |

OPTIONS

| | |
|---------------------|------------------------------------|
| Crankset | RT1 External BB 38t / 42t |
| Brakes | MAGURA MT4 Front + Rear - 180mm |
| Light | B&M LUMOTEC + TOPLIGHT Small |
| Dynamo wheel | SHUTTER PRECISION SP-PD8 |
| F/R mount | 2 X Quick Release axles |
| Handlebar | Flat - 620mm |
| Saddle | Comfort / BROOKS B17 Black - Brown |
| Frame locker | ABUS ProShield 5850 NR |
| Canopy | 600 / 800 |
| Support cosy | STECO Baby-Mee |

COMPONENTS

| | |
|-------------------------|---|
| Handlebar | Moustache - 640mm |
| Stem | 10mm - D1: 28.6 - D2: 31.8 |
| Grips | Ergonomic |
| Saddle | Comfort |
| Seatpost | D 31.6 - Adjustable 2 parts (H82-110cm) |
| Seat clamp | Fix |
| Pedals | City - VP 856 - anti-skid |
| Front/Rear mount | 2 X Anti-theft axles |

TRANSMISSIONS

| | |
|-----------------------|-------------------------------|
| Gears | SRAM Ext Der. XSeries 9V |
| Crankset | First DT1 39t |
| Gear ratios | S1: 2.43m - S9: 7.08m |
| Bottom bracket | Internal 68mm - 1.37"x24t |
| Chain | TAYA Octo DH 1/2"x5/64" |
| Motor | BionX D250 DV / 250 W |
| Battery | Li-Ion 48V / 11.6 Ah / 555 Wh |

INCLUDED ACCESSORIES

| | |
|-------------------|--------------------------------|
| Light | LED Light F/R USB rechargeable |
| Wood board | Anti-skid plywood board |
| Side tube | Aluminium - Powder coated |
| Pack | B |



F5e
GSD

SILENTLY PLEASURABLE

Running powerfully and smoothly, practically inaudible, the Go SwissDrive engine provides sufficient propulsion at any time.

Don't waste energy: the recuperation feature of the motor transforms the energy that is released when braking into electrical power and feeds it directly into the battery.

The double (2X2) cable steering lets you turn the front wheel 75° and the unlocking system allows you to quickly separate the front and rear frame. Looking for a rain cover? As an option you can add our canopy available in two sizes.

► For more information www.douze-cycles.com

FRAMES AND FORK

| | |
|--------------------|---|
| Rear frame | MESSENGER / TRAVELLER / BIG BOY Steel CrMo 4130 |
| Front frame | 600mm / 800mm Aluminium 7005 T6 |
| Color | Matt black / Glossy white - Powder coated |
| Fork | Steel CrMo 4130 - QR 9mm Axle |
| Kickstand | Steel CrMo 4130 |

WHEELS, BRAKES AND STEERING

| | |
|------------------------|---|
| Rear hubs | 135mm - 36H - 10mm Axle - Black |
| Front hubs | 100mm - 36H - QR 9mm Axle - Black |
| Rims | 20"+26"- 36H - Alu dble side - Eyelets |
| Tyres | SCHWALBE Big Apple 26"+20"x2.0" |
| Brakes | TEKTRO Gemini Hydraulic - Disk 180mm |
| Mudguards | Stainless 60mm - Powder coated |
| Steering system | Steering by 2x2 cable + KEVLAR housing |
| Steering column | Adjustable - Easy up |
| R/F Headset | 1" 1/8 semi-integrated |

OPTIONS

| | |
|---------------------|------------------------------------|
| Crankset | RT1 External BB 38t / 42t |
| Brakes | MAGURA MT4 Front + Rear - 180mm |
| Light | B&M LUMOTEC + TOPLIGHT Small |
| Dynamo wheel | SHUTTER PRECISION SP-PD8 |
| F/R mount | 2 X Quick Release axles |
| Handlebar | Flat - 620mm |
| Saddle | Comfort / BROOKS B17 Black - Brown |
| Frame locker | ABUS ProShield 5850 NR |
| Canopy | 600 / 800 |
| Support cosy | STECO Baby-Mee |

COMPONENTS

| | |
|-------------------------|---|
| Handlebar | Moustache - 640mm |
| Stem | 10mm - D1: 28.6 - D2: 31.8 |
| Grips | Ergonomic |
| Saddle | Comfort |
| Seatpost | D 31.6 - Adjustable 2 parts (H82-110cm) |
| Seat clamp | Fix |
| Pedals | City - VP 856 - anti-skid |
| Front/Rear mount | 2 X Anti-theft axles |

TRANSMISSIONS

| | |
|-----------------------|-----------------------------------|
| Gears | SRAM Ext Der. XSeries 9V |
| Crankset | First RT1 42t |
| Gear ratios | S1 : 2.53m S9 : 7.83m |
| Bottom bracket | External |
| Chain | TAYA Octo DH 1/2"x5/64" |
| Motor | GO SwissDrive / 250 W |
| Battery | BMZ Li-Ion 36V / 15,5 Ah / 558 Wh |

INCLUDED ACCESSORIES

| | |
|-------------------|--------------------------------|
| Light | LED Light F/R USB rechargeable |
| Wood board | Anti-skid plywood board |
| Side tube | Aluminium - Powder coated |
| Pack | B |

Frame Kit



Components

Front frame + Rear frame
 2X2 cable steering completely installed
 Kickstand
 Fork for 10mm axle
 2 x Connexion axles
 Dropouts for internal hub or ext. derailleur
 Rear mudguard adapter

Front frame sizes

400
 600
 800

Rear frame types

TRAVELLER
 MESSENGER
 MESSENGER BIG BOY

Colors & Sheen

Glossy white
 Matt black

Packs

PACK A



- Top side tube
- Plastic bowl
- Soft bag
- Top cover

Available for 400, 600, 800

PACK B



- Pack A
- Child seat with two
three point safety belts

Available for 600, 800

PACK C



- Top side tube
- Oyster bag

Available for 400, 600

Canopy



INNOVATION BY DOUZE

The DOUZE canopy is a must-have if you want to keep your kids dry and happy, in any weather. Its inflatable structure makes it very light and easy to fold away. The design is pure DOUZE. Lovingly hand-crafted by our seamstress in our Beaune workshop.

Available for both the 600 and 800 front frame

DOUZE CYCLES



www.douze-cycles.com

DOUZE Cycles - 2 rue des Trois Noyers - ZA les Lauchères - 21550 Ladoix-Serrigny - FRANCE - Tél: +33(0)9 72 47 41 15 - info@douze-cycles.com
DOUZE Cycles reserves the right to alter specifications without prior notice at any time. Non-contractual pictures.